

## Advanced Security from Devices to Cloud Native

Platform approach to OT and cloud-native security

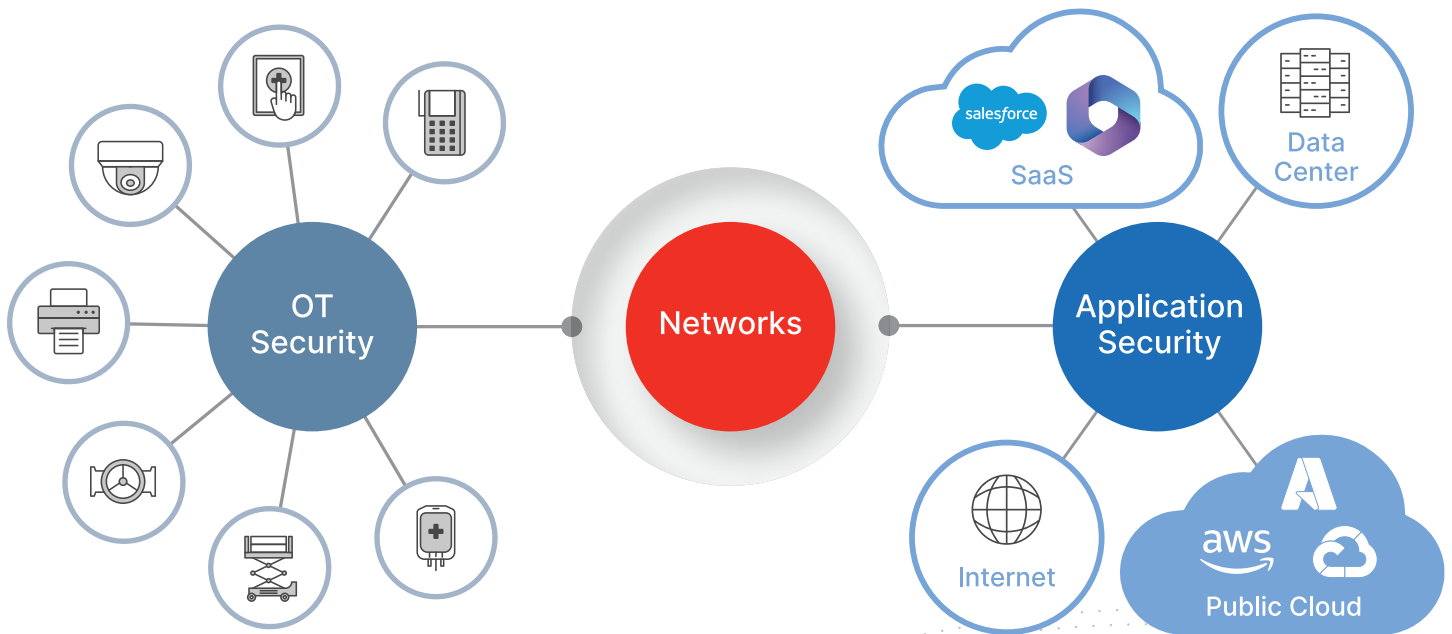

**Enhanced Operational  
Technology Security Platform**

**Cloud-Native Application  
Protection Platform (CNAPP)**

- **Founded:** October 2000
- **Member of:** Dow Jones Sustainability Index
- **Headquarters:** Sunnyvale, CA
- **NASDAQ 100 and S&P 500**
- **Fortinet IPO (FTNT):** November 2009

## FY 2023 Results

Revenue \$5.305B  
Billings \$6.40B

## Q2 2024 Results

Revenue \$1.434B  
Billings \$1.541B  
Op. Margin (GAAP) 30.5%

Cash + Investments \$3.339B  
Market Cap \$46.1B  
AS OF JUNE 30, 2024

## Customers

775,000+

## Cumulative Units Shipped

12.7+ Million

## Headcount by Region

	U.S.	3,753
AMERICAS	CANADA	2,627
	REST OF AMERICAS	983
	FRANCE	518
EMEA	U.K.	450
	REST OF EMEA	2,477
	INDIA	721
APAC	JAPAN	621
	REST OF APAC	1,377
TOTAL		13,527

ALL INFORMATION AS OF MARCH 31, 2024

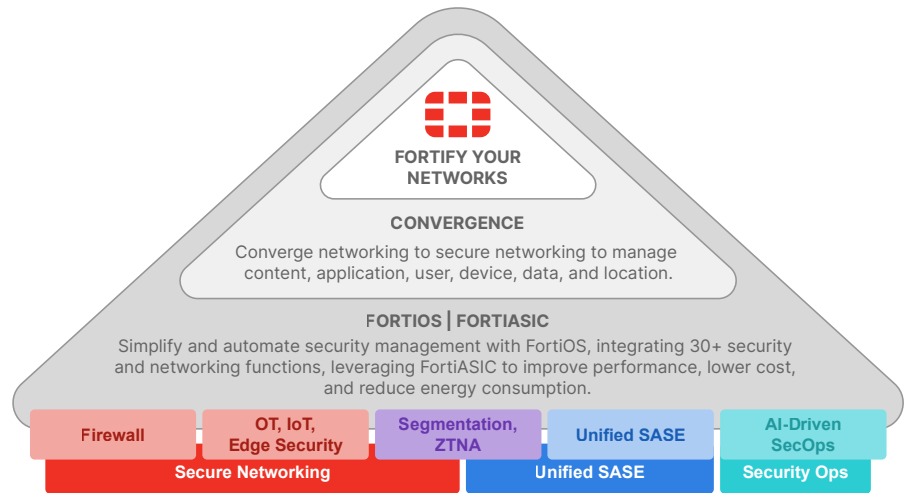

## Global Leader in Product Growth with Strong Growth in Annual Billings and Profitability

GAAP profitable every year since IPO

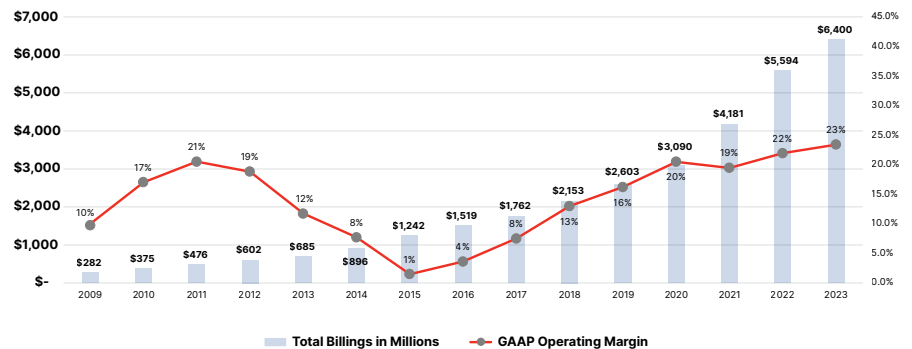

2009-2024 CAGR: 23%

## Highly Diversified Across Regions and Segments

Q2 2024 REVENUE BY REGION

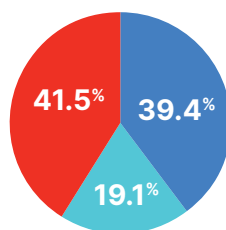

■ AMERICAS ■ EMEA ■ APAC

Q2 2024 BILLINGS BY SEGMENT

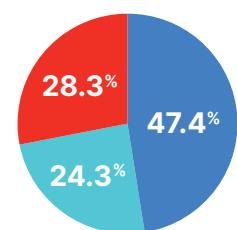

■ HIGH-END ■ MIDRANGE ■ ENTRY-LEVEL

# #1 Network Security Company in the World

## #1 in Enterprise

73% of Fortune 100 and 69% of Global 2000 depend on Fortinet to stay secure.



## #1 in Network Security

"Fortinet is the #1 vendor for firewall shipments globally with more than 50% share."  
-650 Group

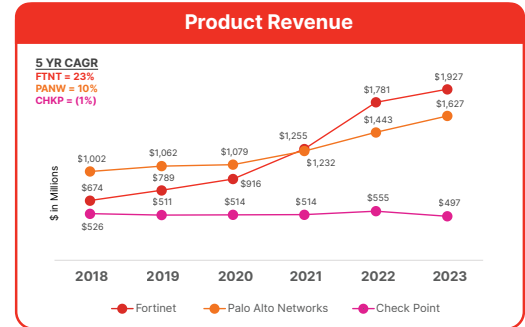
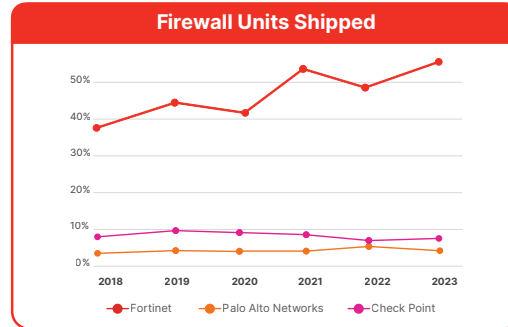

## #1 in Innovation

2x more patents than comparable cybersecurity companies.

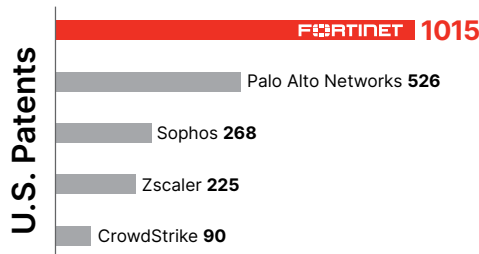

Source: U.S. Patent Office, as of June 30, 2024

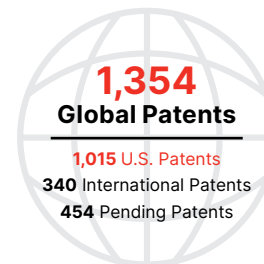

Includes patents from Lacework and Next DLP acquisitions

## Innovation ~\$2.5B

investment in innovation since 2017, with 91% R&D

## Capital Return ~\$6.1B

repurchased 219M shares since 2017

## #1 Most Third-Party Validated

Leadership positions in eight Gartner Magic Quadrants.

**100+** Enterprise Analyst Reports Validate Fortinet Across Networking and Security

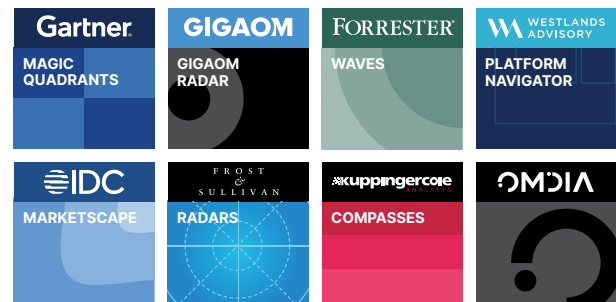

## #1 in Product Energy-Efficiency

Product environmental impacts are central to our sustainability approach.

## Second Consecutive Year Member of Dow Jones Sustainability Indices

Powered by the S&P Global CSA

## Pledge to Reach Net Zero

By 2030 across scopes 1 and 2 emissions from Fortinet's owned facilities worldwide.



## Lead in Energy-Efficiency

**88%** less power consumption over industry-standard CPU  
**62%** average reduction on product energy consumption<sup>1</sup>

<sup>1</sup> Based on new models of 2022 FortiGate F series (compared to equivalent models from previous generation).

# Security at the Application and Content Layers

Designed 50 years ago, most networking protocols still rely on trust, allowing cyberattacks to hide in application and content layers. Fortinet Secure Networking uses a zero-trust strategy to verify all applications, content, data, users, devices, and locations before connecting.

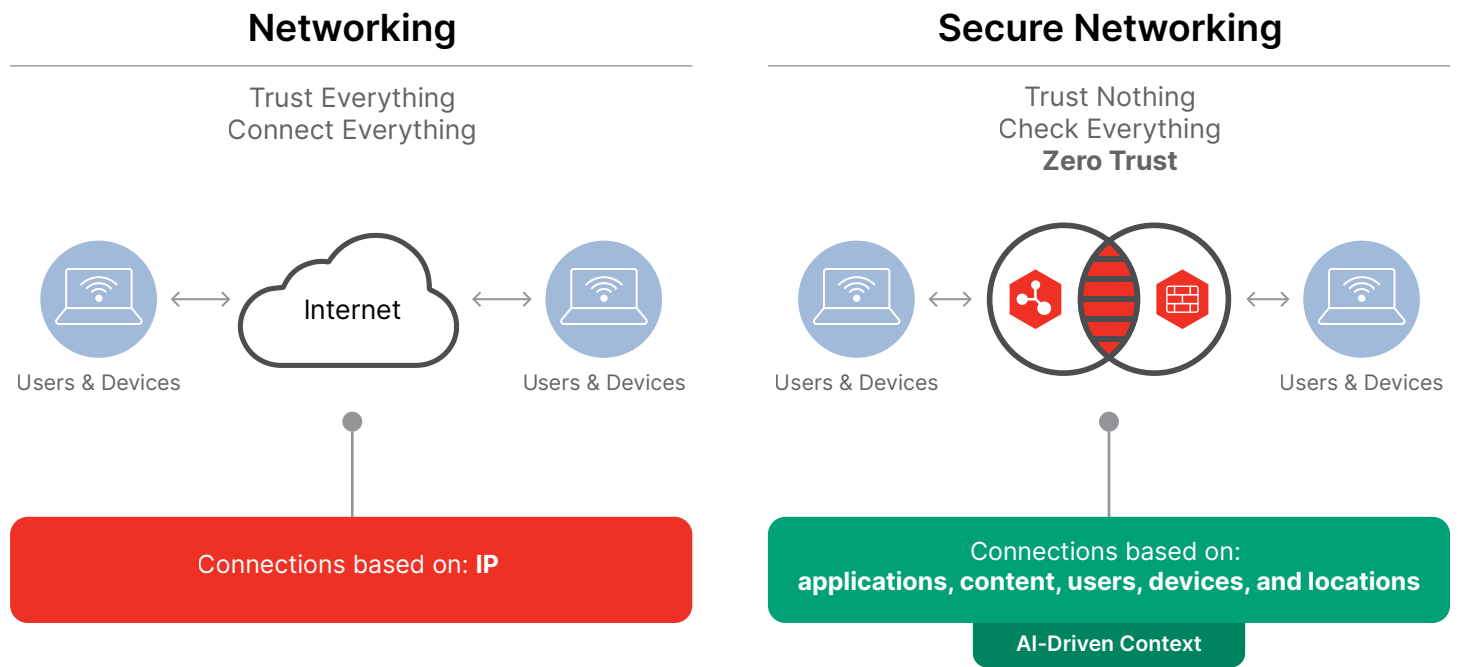

## Total TAM of \$187B in 2024, Growing to \$282B by 2028

Gartner predicts secure networking will surpass connection-only networking by 2030 as organizations prioritize investments in solutions like NGFW, Secure SD-WAN, SASE, and ZTNA. This shift requires closer collaboration among networking and security teams, particularly in the NOC and SOC.

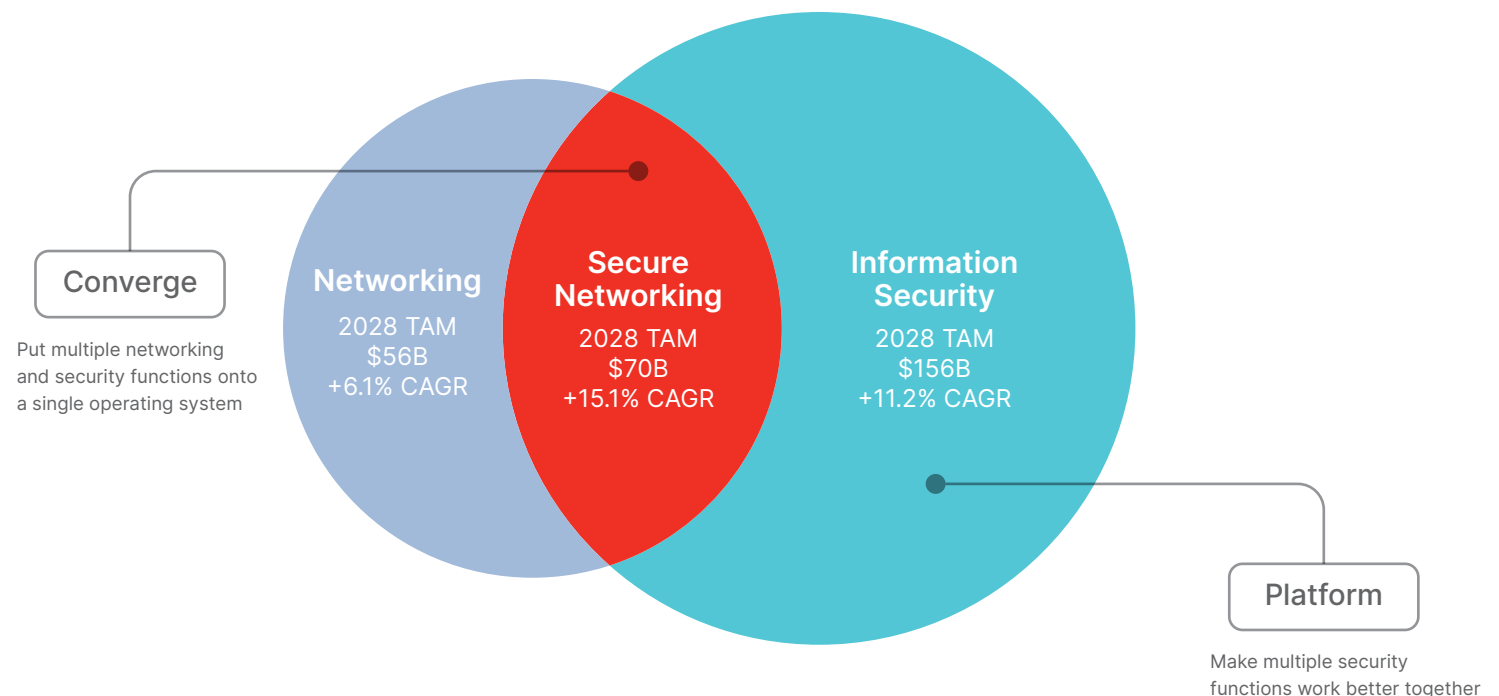

# Converged Network Operating System and Security Fabric Platform

Our platform addresses the three critical cybersecurity approaches organizations need to meet evolving business requirements: simplify complex networks, distributed users, and hybrid applications through security convergence and consolidation, with flexible consumption models for easy purchasing.

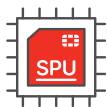
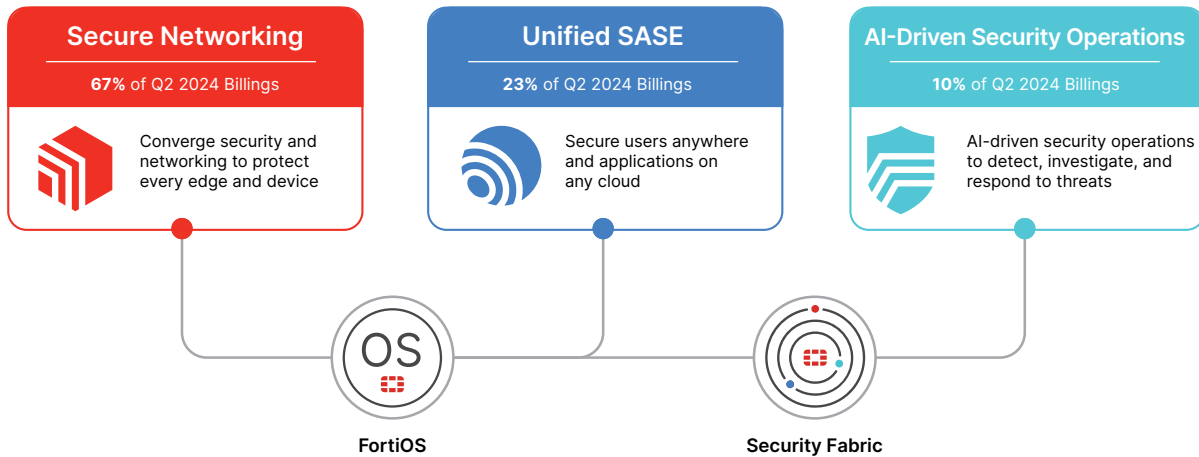

## The Only Purpose-Built Proprietary ASIC

Fortinet's ASIC-based security processing units (SPUs) enhance speed, efficiency, and value, improve user experience, and reduce footprint and power needs. Our SPU-powered appliances deliver superior Security Compute Ratings in all environments.

### Network Processor 7 NP7



Network processors operate inline to deliver unmatched performance for network functions and hyperscale for stateful firewall functions.

### Content Processor 9 CP9

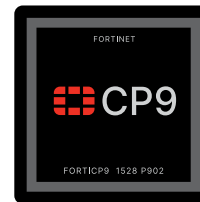

As a co-processor to the main CPU, content processors offload resource-intensive processing and drive content inspection to accelerate security functions.

### Security Processor 5 SP5



The security processor consolidates network and content processing, delivering fast application identification, steering, and overlay performance.

FortiSP5 concurrently supports 2x more applications than the previous generation.

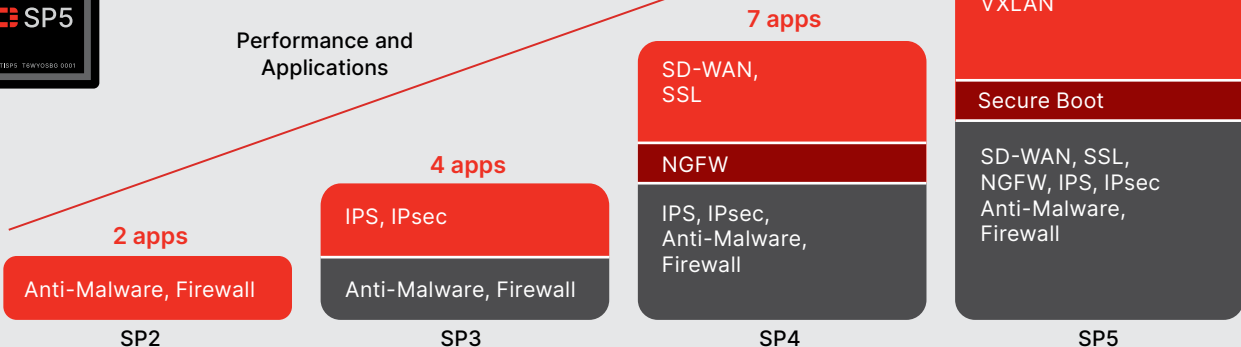



# Technology Advancements Enable Refresh and Replace Opportunities

Firewall appliances typically need replacing every four to five years to maintain performance and functionality. Fortinet FortiGate firewalls are 5–10x faster than competitors’ firewalls, with more integrated and automated functions, while FortiOS and FortiASIC integration makes them 5x more power efficient.

**Better Performance**



**Security Compute Rating**

---

**7x** better than the competition

201G Security Compute Rating

**Better Efficiency**



**Security Compute Rating - Energy**

---

**29x** better than the competition

90G Security Compute Rating

**Better Security**



**FortiGuard Labs**

---

**99.98%** security effectiveness

Competitors: <80% security effectiveness

NetSecOPEN Certification Lab Report

Data Center Perimeter Firewall



Core Segmentation Firewall



Distributed Firewall



Firewall-as-a-Service



OT Firewall



Cloud-Native Firewall



Virtual Machine Firewall



Container Firewall



Expand to Hybrid Mesh Firewall

## FortiGate Rugged 70G NGFW with Dual 5G Modem



reddot winner 2024

The FortiGate Rugged with dual 5G modems introduces high availability 5G to its industrial NGFW capability and industry-leading performance with the advanced SP5 security processing chip. When coupled with the Fortinet AI-Powered OT Security Service, the rugged FortiGate delivers OT device and application security at a high throughput and intrusion prevention system with deep packet inspection to detect and block IT and OT malicious network traffic and protect vulnerable OT devices.



 Energy-efficiency

 Cutting-edge SP5 security chip

 New standard in network connectivity

Performance numbers taken from external data sheets match as closely as possible. Different testing methodologies may be applied by different vendors.

Specifications	Fortinet FortiGate Rugged 70G-5G-Dual	Security Compute Rating	Competitive Average	Allied Telesis AR4050S-5G	Check Point Quantum 1570R	Check Point Quantum 1595R	Palo Alto Networks PA-450R
Firewall (Gbps)	8	3.6x	2.22	1.9	1.9	1.9	3.2
IPsec VPN (Gbps)	7	6.4x	1.10	-	1.1	1.1	-
Threat Protection (Gbps)	1.1	1.5x	0.73	-	0.4	0.4	1.4
Concurrent Sessions	1,400,000	3.7x	375,000	300,000	500,000	500,000	200,000
Connections Per Second	85,000	7x	12,250	12,000	13,500	13,500	10,000
Cellular Wireless Modem	2x 5G	-	-	1x 5G	1x 3G/4G LTE	1x 5G	1x 5G
Signatures Covered for OT Protocols	3,060	2.5x	1,210	6	1,838	1,838	1,156

Power-Efficiency							
Max Power Consumption (Watts)	29	1.2x	34.6	28.0	30.7	29.5	50.0
BTU/hr	98.9	1.3x	125.1	95.5	104.8	100.6	170.0
Watts/Gbps Firewall Throughput	3.6	4.2x	15.4	14.7	16.2	15.5	15.1
Watts/Gbps IPsec VPN Throughput	4.1	6.6x	27.4	NA	27.9	26.8	NA
BTU/hr per Gbps of Firewall Throughput	12.4	4.2x	52.4	50.3	55.2	52.9	51.2

# The Only Way to Secure Agentless Devices Is Through Secure Networking

Securing OT/IoT devices, which often cannot support security agents, relies on secure networking. Fortinet, a leader in OT/IoT security, offers the broadest range of solutions tailored to healthcare, manufacturing, utilities, and more, as recognized in the Westlands Advisory Platform Navigator report.

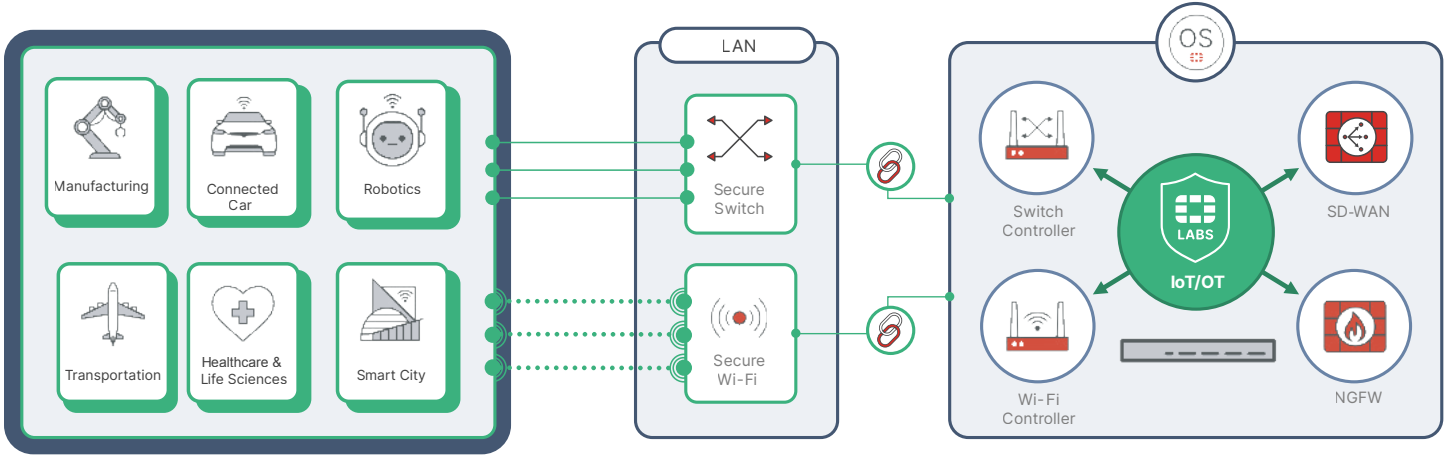

## Detect and Respond to Sophisticated Cyberthreats Faster

Our AI-driven, automated security operations solution provides extensive attack surface and kill chain coverage, speeding up detection, containment, investigation, and response across your infrastructure.

### NIST Cybersecurity Framework

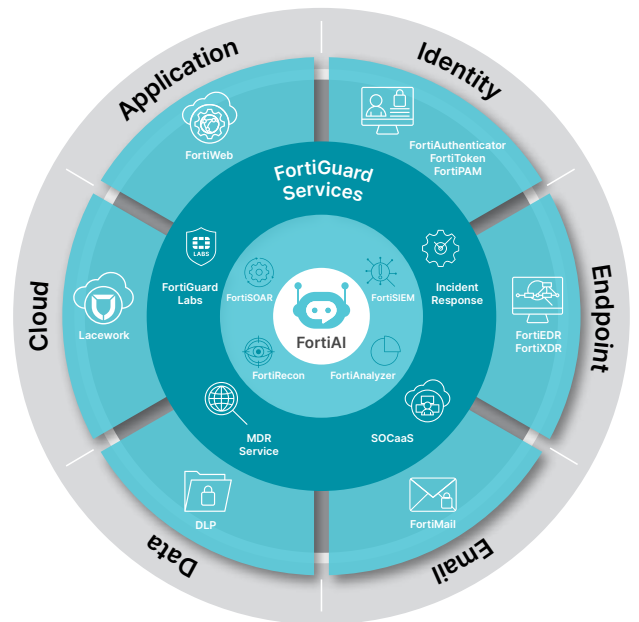
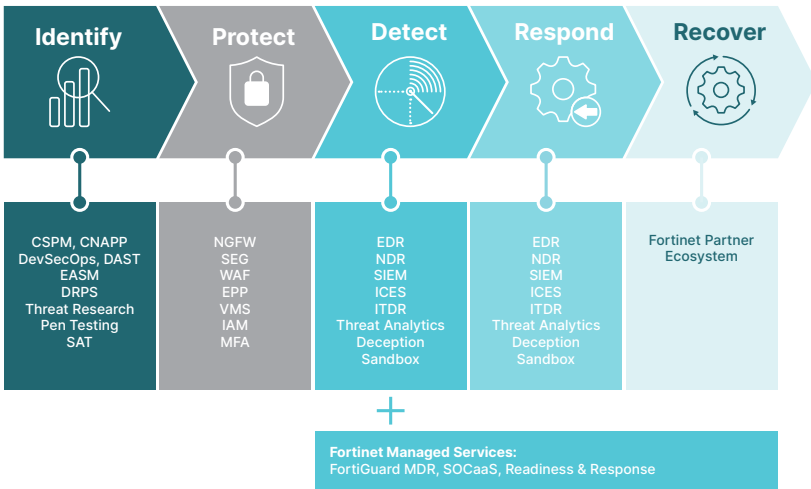



# Single-Vendor SASE Requires a Hybrid Approach

Fortinet's Unified SASE provides two advantages over competitors: It's the only solution to integrate all SASE functions, including SD-WAN and SSE, directly into FortiOS, and it uniquely offers SASE deployment in both cloud and on-premises environments using software and hardware agents.

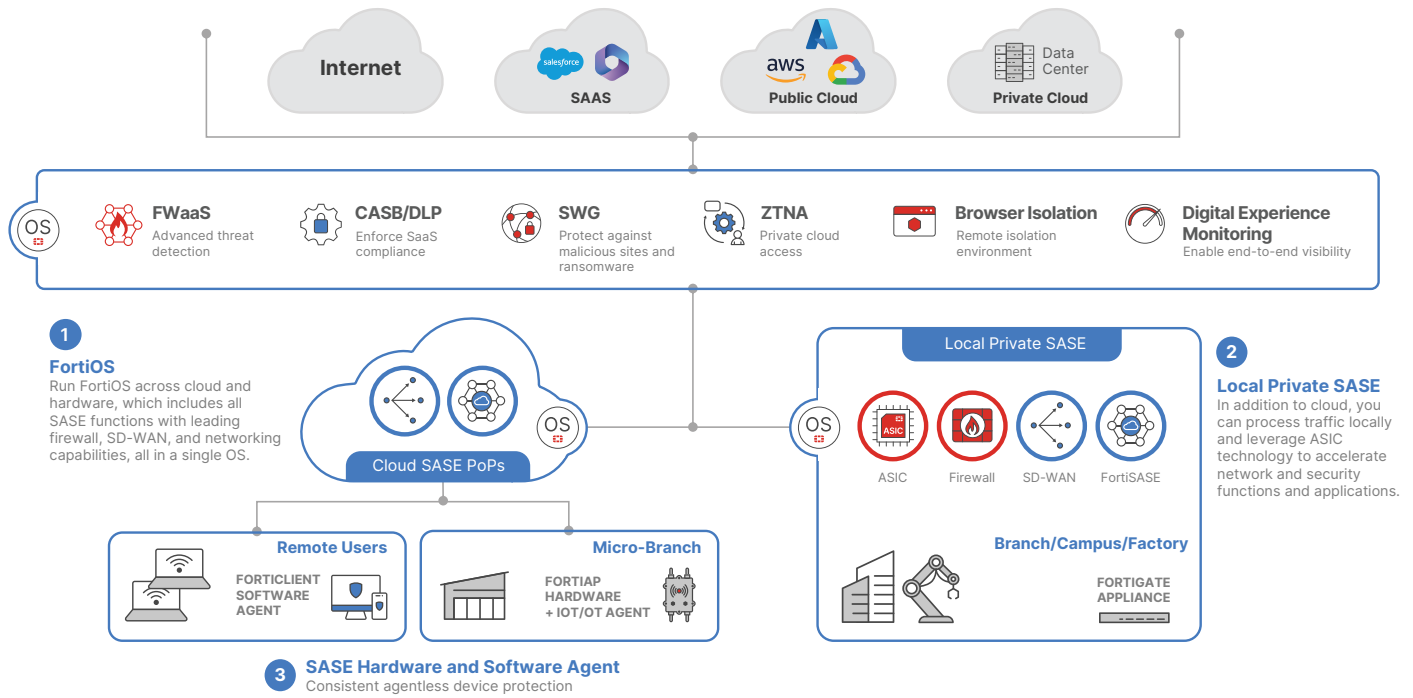

## Fortinet + Lacework: Complete Platform to Secure Code-to-Cloud

Lacework FortiCNAPP is a unified AI-driven platform to cover all aspects of cloud security and CI/CD application development. Its agent-based and agentless options help manage risks, reduce alert noise, and streamline cloud operations to simplify your security from code-to-cloud.

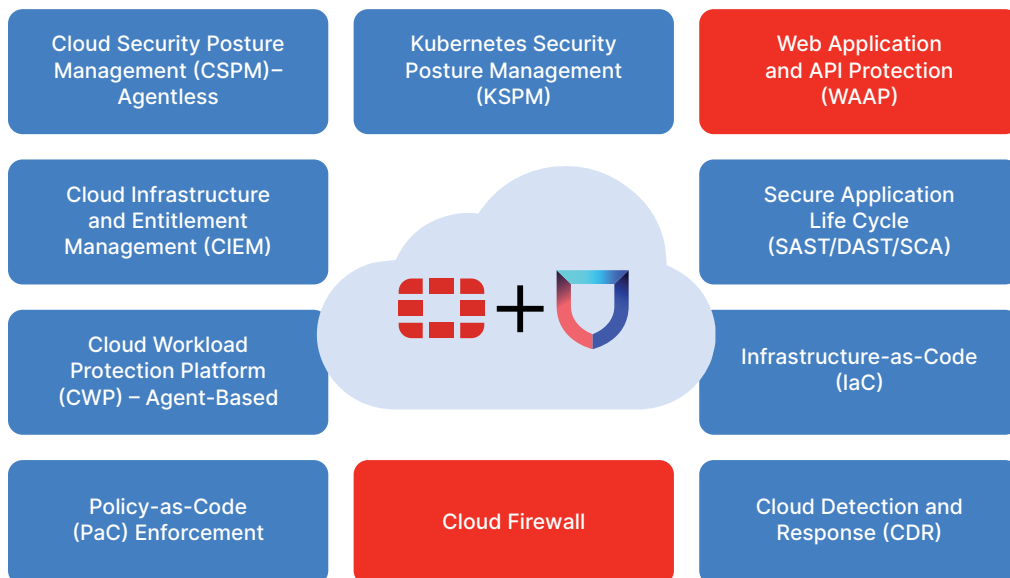





# FortiGuard Labs: The AI Engine Behind Advanced, Proactive Security

FortiGuard Labs, Fortinet’s elite cybersecurity research organization, offers timely protection and actionable threat intelligence to customers and collaborates with law enforcement, government agencies, and security vendors worldwide to tackle emerging risks. FortiGuard Labs enhances the Fortinet Security Fabric with AI/ML-driven, proactive, and unified defense capabilities.



### Trusted ML and AI

Stop unknown threats faster with a powerful combination of actionable local learning and AI and ML models on large-scale, cloud-driven data lakes.



### Real-Time Threat Intelligence

Achieve a proactive security posture with continuous security updates based on in-house research and collaboration.



### Threat Hunting and Outbreak Alerts

Achieve faster remediation with alerts, analysis and detection, prevention and remediation tools, including outbreaks.

Global Leadership and Collaboration



## FortiGuard AI-Powered Security Services

Fortinet’s industry-leading security capabilities have been unified into a single security framework to deliver coordinated, context-aware policy for hybrid deployments across networks, endpoints, and clouds, continually assessing risk and automatically adjusting prevention to counter known and unknown threats in real time.

### Market-Leading Security-as-a-Service

ML-enabled security, deployed close to the protected assets, powered by FortiGuard Labs.

### Consistent Context-Aware Policy

Centralized detection and prevention delivered from the cloud and built for hybrid environments.

### Coordinated Real-Time Prevention

Continuous risk assessment and automatic response to counter known and unknown threats.



## FortiCare: Expertise at Your Service

Learn more at [fortinet.com/support](https://fortinet.com/support)

FortiCare Services supports thousands of organizations, ensuring they get the most from their Fortinet Security Fabric solutions. With over 1,900 experts, we offer accelerated implementation, reliable assistance, and proactive care whether on-prem, cloud-based, or hybrid. We support you through your entire digital journey—from design and implementation to optimization and ongoing management—allowing you to focus on your business needs.

**1,900+**  
EXPERTS



**24x7**  
TECHNICAL  
SUPPORT



**23**  
GLOBAL SUPPORT  
CENTERS



# Our Global Partner Commitment

Fortinet leverages a global network of trusted advisors to secure your digital acceleration and strategically drive business growth.



The Engage Partner Program helps partners leverage Fortinet solutions to drive customer success. Our global partner program is driven by three concepts:

## Growth through Technology Differentiation

Our broad portfolio is integrated into an automated, high-performance platform that spans endpoints, networks, remote workers, and clouds.



## Business Success with Proven Credibility

Our technology innovation and industry-leading threat intelligence, alongside customer ratings and independent analyst reports, validate and differentiate partner offerings.

## Long-Term, Sustained Growth

The Engage Partner Program provides sales, marketing, and executive support so partners can grow successful relationships. With growth drivers like specializations built into the program, we provide solutions that are driving market demand, ensuring partners are positioned for success.

# FORTINET Training Institute

Fortinet has pledged to train 1 million people by 2026 through our Training Advancement Agenda (TAA) and award-winning Training Institute programs.

## NSE Certification Program

The NSE Certification Program provides 12 certifications across five career paths, from foundational to expert levels. Supported by 153 Authorized Training Centers in over 150 countries, it covers OT Security, Security Operations, Network Security, SASE, Public Cloud Security, and Zero Trust Access.

## Training and Education Programs

Fortinet has increased access to certifications to a diverse population, including women, minorities, veterans, and other underrepresented groups.

## Security Awareness and Training Service

Awareness and training on today's cybersecurity threats help IT, security, and compliance leaders build a cyber-aware culture.



**1,677,000+**  
CERTIFICATIONS



**729**  
ACADEMIC  
PARTNERS IN 102  
COUNTRIES



**49**  
EDUCATION OUTREACH  
AND VETERANS  
PROGRAM PARTNERS

# 100+

## Enterprise Analyst Reports Validate Fortinet Across Networking and Security

Fortinet is one of the most validated enterprise cybersecurity companies in the world. We continually rank in leadership positions across dozens of analyst reports, highlighting the broad application of the Fortinet Security Fabric.

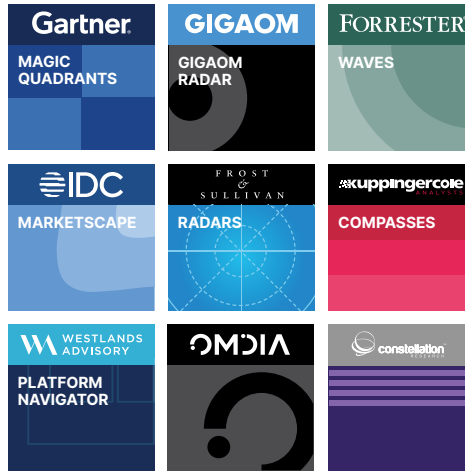

Learn more at [fortinet.com/solutions/analyst-reports](https://fortinet.com/solutions/analyst-reports)

## Fortinet is recognized in 8 Gartner® Magic Quadrant™ reports based on the Fortinet Security Fabric Platform

Fortinet's network security offerings are uniquely based on one operating system, FortiOS, and seamlessly integrates into the Security Fabric platform, so customers can better mitigate risk, reduce complexity, and realize a superior user experience.



Network Firewalls



SD-WAN Infrastructure



Single-Vendor SASE



Endpoint Protection Platforms



Wired and WLAN



SIEM



Security Service Edge



Access Management

## Third-Party Testing and Certifications

Fortinet submits its products for impartial, third-party performance and effectiveness testing with the most prominent organizations in the industry, with consistent positive results.



Antiphishing approved



100% protection, two years in a row



Highest "VBSpam+" rating



Near perfect score for WAF at 96%

GARTNER and MAGIC QUADRANT are registered trademarks and service marks of Gartner, Inc. and/or its affiliates in the U.S. and internationally and are used herein with permission. All rights reserved. Gartner Peer Insights content consists of the opinions of individual end users based on their own experiences with the vendors listed on the platform, should not be construed as statements of fact, nor do they represent the views of Gartner or its affiliates. Gartner does not endorse any vendor, product or service depicted in this content nor makes any warranties, expressed or implied, with respect to this content, about its accuracy or completeness, including any warranties of merchantability or fitness for a particular purpose.

## CUSTOMER RECOGNITION



Gartner Peer Insights Customers' Choice distinctions are based on the ratings of vendors by verified end-user professionals across a variety of industries and from locations around the world. These distinctions take into account both the number of end-user reviews a vendor receives, along with the overall ratings score a vendor receives from those end-users.

### Fortinet is proud to be named a Gartner Peer Insights Customers' Choice in several critical areas:

- Wired and Wireless LAN
- Network Firewalls
- SD-WAN
- Email Security
- Security Service Edge (SSE)
- Endpoint Protection Platforms (EPP)

See our Gartner Peer Insights reviews and distinctions at [www.gartner.com/reviews](https://www.gartner.com/reviews)

Gartner, Gartner Peer Insights 'Voice of the Customer': Network Firewalls, Peer Contributors, 9 April 2021

Gartner, Gartner Peer Insights 'Voice of the Customer': Wired and Wireless LAN Access Infrastructure, Peer Contributors, 12 May 2021

Gartner, Gartner Peer Insights 'Voice of the Customer': Email Security, Peer Contributors, 5 February 2021

Gartner, Gartner Peer Insights 'Voice of the Customer': WAN Edge Infrastructure, Peer Contributors, 5 February 2021

Gartner, Gartner Peer Insights 'Voice of the Customer': Security Service Edge (SSE), Peer Contributors, 29 September 2023

Gartner, Gartner Peer Insights 'Voice of the Customer': Endpoint Protection Platforms, Peer Contributors, 18 September 2023

The GARTNER PEER INSIGHTS CUSTOMERS' CHOICE badge is a trademark and service mark of Gartner, Inc. and/or its affiliates and is used herein with permission. All rights reserved. Gartner Peer Insights Customers' Choice constitute the subjective opinions of individual end-user reviews, ratings, and data applied against a documented methodology; they neither represent the views of, nor constitute an endorsement by, Gartner or its affiliates.

# Fortinet secures over 775,000 enterprises, service providers, and government organizations around the world.

## IHG

HOTELS & RESORTS

Global hospitality company with 18 hotel brands and over 6,000 hotels in over 100 countries and more than 1,900 in development.

HQ: EMEA



DP WORLD

Leading men's professional golf tour in Europe, featuring tournaments all over European regions.

HQ: EMEA



Australia's largest private rail freight operator. Operating 24 hours a day, seven days a week, 365 days a year.

HQ: APAC



2,400+ locations nationwide and consistently ranked in the top 10 franchises in America in *Entrepreneur* magazine's annual Franchise 500.

HQ: NAM



Global food company with a presence in over 33 countries with an annual sales revenue of over 15 billion dollars.

HQ: LATAM

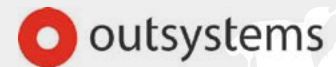

Global leader in high-performance low-code application development of mobile and web enterprise applications.

HQ: US and EMEA



Global industrial leader in technology and aerospace manufacturer and service provider.

HQ: US



Largest North American automotive services company parent to Take 5 Oil Change, Meineke Car Care Centers, Maaco, 1-800-Radiator & A/C, and CARSTAR.

HQ: NAM



Multinational retail and wholesaling corporation composed of 14,000 stores in over 30 countries, the seventh largest retailer in the world by revenue.

HQ: EMEA

Visit [fortinet.com/customers](https://fortinet.com/customers) to see how our customers benefit from Fortinet solutions and the Fortinet Security Fabric.



Copyright © 2024 Fortinet, Inc. All rights reserved. Fortinet®, FortiGate®, FortiCare® and FortiGuard®, and certain other marks are registered trademarks of Fortinet, Inc., and other Fortinet names herein may also be registered and/or common law trademarks of Fortinet. All other product or company names may be trademarks of their respective owners. Performance and other metrics contained herein were attained in internal lab tests under ideal conditions, and actual performance and other results may vary. Network variables, different network environments and other conditions may affect performance results. Nothing herein represents any binding commitment by Fortinet, and Fortinet disclaims all warranties, whether express or implied, except to the extent Fortinet enters a binding written contract, signed by Fortinet's General Counsel, with a purchaser that expressly warrants that the identified product will perform according to certain expressly-identified performance metrics and, in such event, only the specific performance metrics expressly identified in such binding written contract shall be binding on Fortinet. For absolute clarity, any such warranty will be limited to performance in the same ideal conditions as in Fortinet's internal lab tests. Fortinet disclaims in full any covenants, representations, and guarantees pursuant hereto, whether express or implied. Certain offerings mentioned herein may not be generally available, and Fortinet reserves the right to change, modify, transfer or otherwise revise this publication without notice, and the most current version of the publication shall be applicable.

Revision: Q4 / 2024 v1 August 16, 2024 2:02 PM